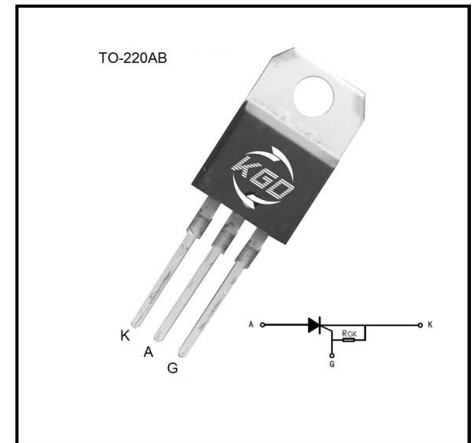

Description:

Highly sensitive triggering levels, the BT150 Series SCRs is suitable for all applications, where the available gate current is limited, such as capacitive discharge ignitions, motor control in kitchen aids, overvoltage crowbar protection in low power supplies...

Features:

Blocking voltage to 500V
 On-state RMS current to 8A
 Non-repetitive peak on-state current to 70A

Absolute Maximum Ratings

Symbol	Parameter	Conditions	Value	Unit	
V_{DRM}	Repetitive peak off-state voltage	$T_J=25^\circ\text{C}$	500	V	
V_{RRM}	Repetitive peak Reverse voltage	$T_J=25^\circ\text{C}$	500	V	
$I_{T(RMS)}$	RMS on-state current (180° conduction angle)	$T_c=105^\circ\text{C}$	8	A	
$I_{T(av)}$	Average on-state current (180° conduction angle)	$T_c=105^\circ\text{C}$	5	A	
I_{TSM}	Non-repetitive surge peak On-state current ($T_J=25^\circ\text{C}$)	$t_p=10\text{ms}$	70	A	
		$t_p=8.3\text{ms}$	73		
I^2t	I^2t Value for fusing	$t_p=10\text{ms}$	24.5	A^2S	
di/dt	Rate of rise of on-state current	$I_G=2 \times I_{GT}, t_r \leq 100\text{ns}, f=50\text{Hz}, T_J=110^\circ\text{C}$	50	A/us	
I_{GM}	Peak gate current	$t_p=20\mu\text{s}, T_J=125^\circ\text{C}$	4	A	
$P_{G(AV)}$	Average gate power dissipation		1	W	
T_{STG}	Storage temperature		-40	150	$^\circ\text{C}$
T_J	Junction temperature		-40	110	$^\circ\text{C}$

● Electrical Characteristics

Symbol	Conditions	Value			Unit
		MIN	TYP	MAX	
I_{GT}	$V_D=6V, R_L=140\Omega$	/	/	100	μA
V_{GT}		/	/	0.8	V
V_{GD}	$V_D=V_{DRM}, R_L=3.3K\Omega, R_{GK}=220\Omega, T_j=125^\circ C$	0.1	/	/	V
I_L	$I_G=1mA, R_{GK}=1K\Omega$	/	/	6	mA
I_H	$I_T=50mA, R_{GK}=1K\Omega$	/	/	5	mA
dv/dt	$V_{DM}=65\%V_{DRM}, R_{GK}=220\Omega, T_j=125^\circ C$	5	/	/	$V/\mu s$

● Electrical Characteristics

Symbol	Parameter	Numerical	Unit
V_{TM}	$I_T=16A, tp=380\mu s$ $T_j=25^\circ C$	1.6	V
I_{DRM}	$V_D=V_{DRM}, V_R=V_{RRM}, R_{GK}=220\Omega$ $T_j=25^\circ C$	5	μA
I_{RRM}	$T_j=125^\circ C$	1	mA
R_{GK}		6-35	K Ω

● Thermal Characteristics

Symbol	Parameter	Numerical(MAX)	Unit
$R_{th(j-c)}$	Junction to case(DC)	20	$^\circ C/W$

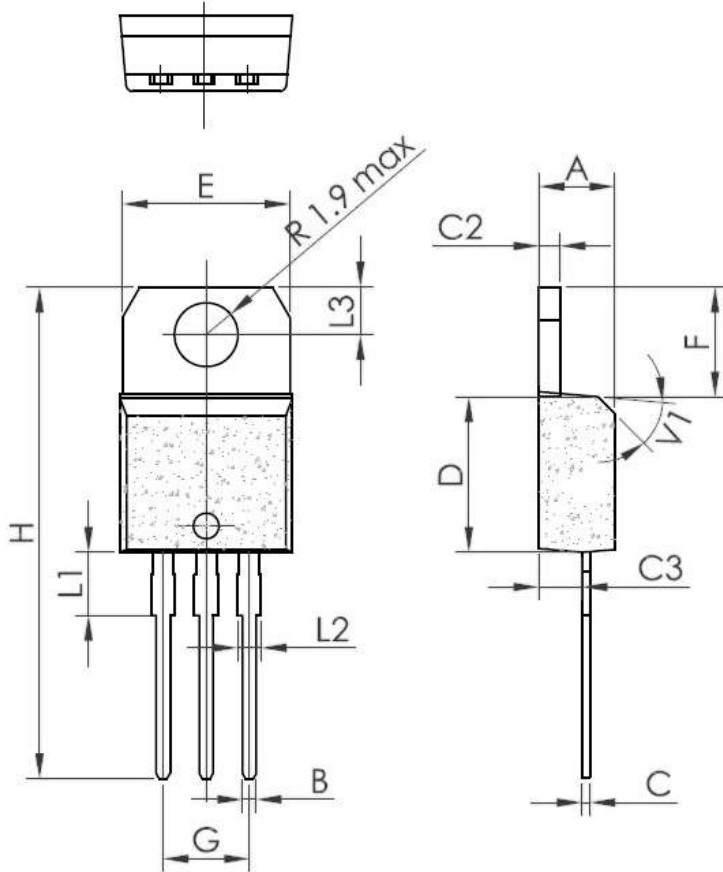
Package Outline Dimensions
TO-220AB

Ref.	Dimensions					
	Millimeters			Inches		
	Min.	Typ.	Max.	Min.	Typ.	Max.
A	4.4		4.6	0.173		1.181
B	0.61		0.88	0.024		0.034
C	0.49		0.70	0.019		0.027
C2	1.23		1.32	0.048		0.051
C3	2.4		2.72	0.094		0.107
D	8.6		9.7	0.338		0.382
E	10		10.4	0.393		0.409
F	6.2		6.6	0.244		0.259
G	4.8		5.4	0.189		0.213
H	28.0		29.8	11.0		11.7
L1		3.75			0.147	
L2	1.14		1.7	0.044		0.066
L3	2.65		2.95	0.104		0.116
V1		40°			40°	

Fig. 1: Maximum average power dissipation versus average on-state current.

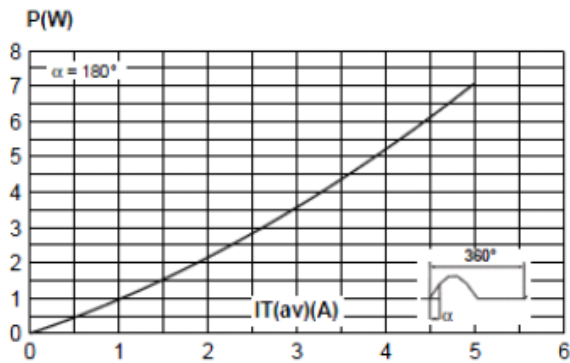

Fig. 2: Average and D.C. on-state current versus lead temperature.

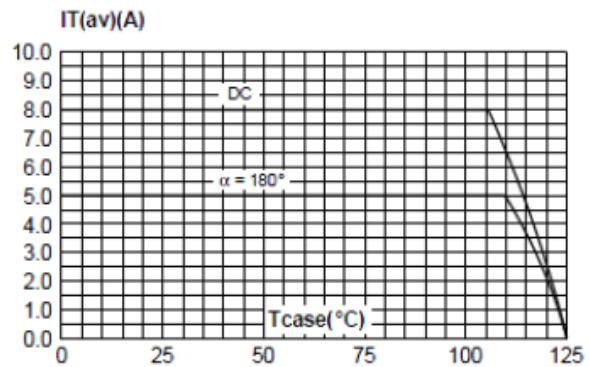

Fig. 3: Surge peak on-state current versus number of cycles.

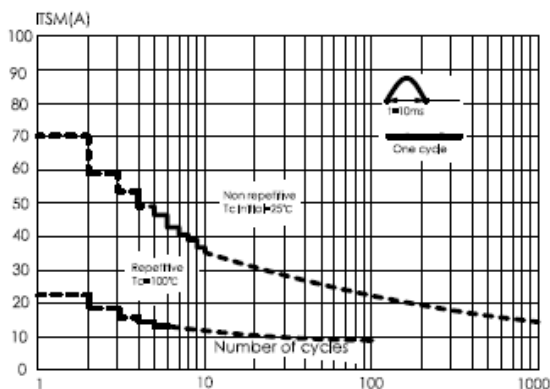

Fig. 4: Non-repetitive surge peak on-state current for a sinusoidal pulse with width $t_p < 10$ ms, and corresponding value of I^2t .

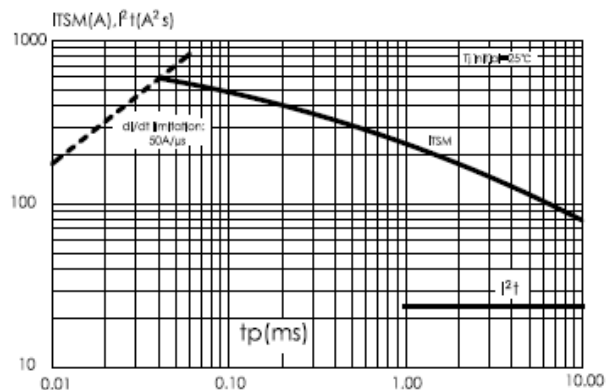

Fig. 5: Relative variation of gate trigger current, holding current and latching current versus junction temperature (typical values).

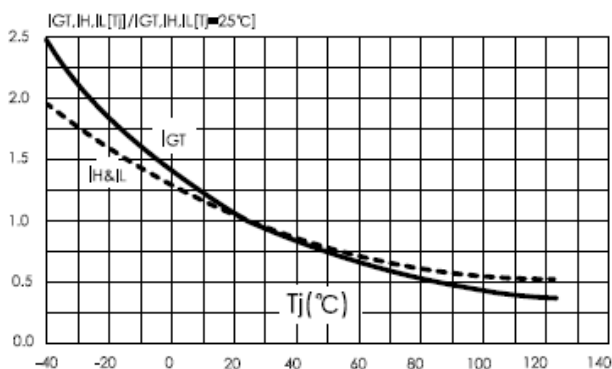

Fig.6: On-state characteristics (maximum values)

